

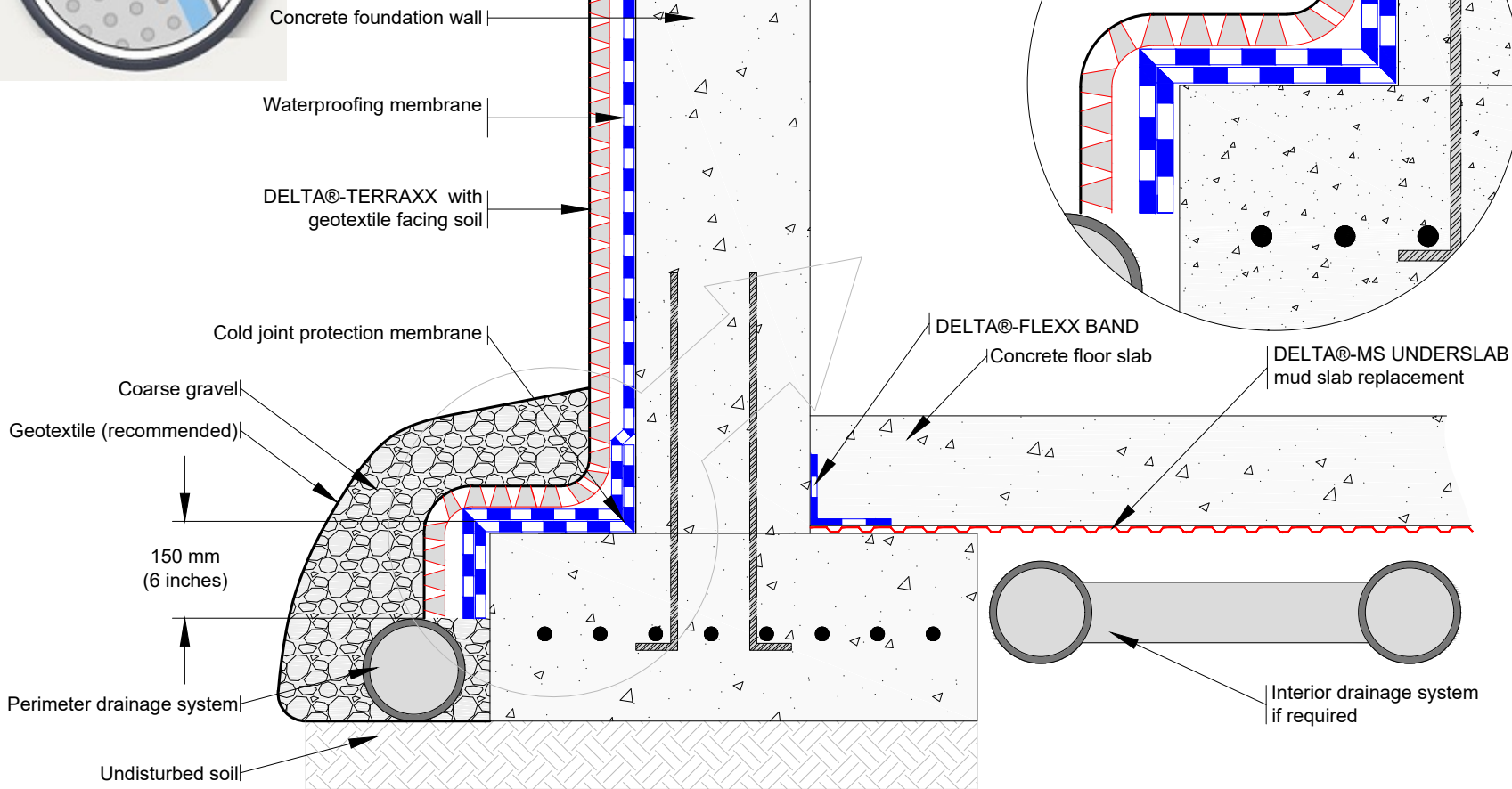

Note: gravel not shown for clarity



SUBSTANTIAL EFFORT HAS BEEN MADE TO ENSURE THAT THE INFORMATION IN THIS DETAIL DRAWING IS ACCURATE. COSELLA-DORKEN PRODUCTS INC. CANNOT ACCEPT RESPONSIBILITY FOR ANY ERRORS OR OVERSIGHTS IN THE USE OF THIS MATERIAL OR IN THE PREPARATION OF ARCHITECTURAL OR ENGINEERING PLANS. THE DESIGN PROFESSIONAL MUST RECOGNIZE THAT NO DESIGN DETAIL CAN SUBSTITUTE FOR EXPERIENCED ENGINEERING AND PROFESSIONAL JUDGEMENT.

TITLE:

**DELTA®-TERRAXX WITH FOUNDATION WALL AND FLOOR SLAB AT FOOTING LEVEL**

DRAWN BY: Krzysztof Apriasz C. Tech., CPHC®

DATE: November 15, 2022  
SCALE: NTS

FILE NAME:  
DTERRAXX\_1



**DELTA®**



Note: gravel not shown for clarity

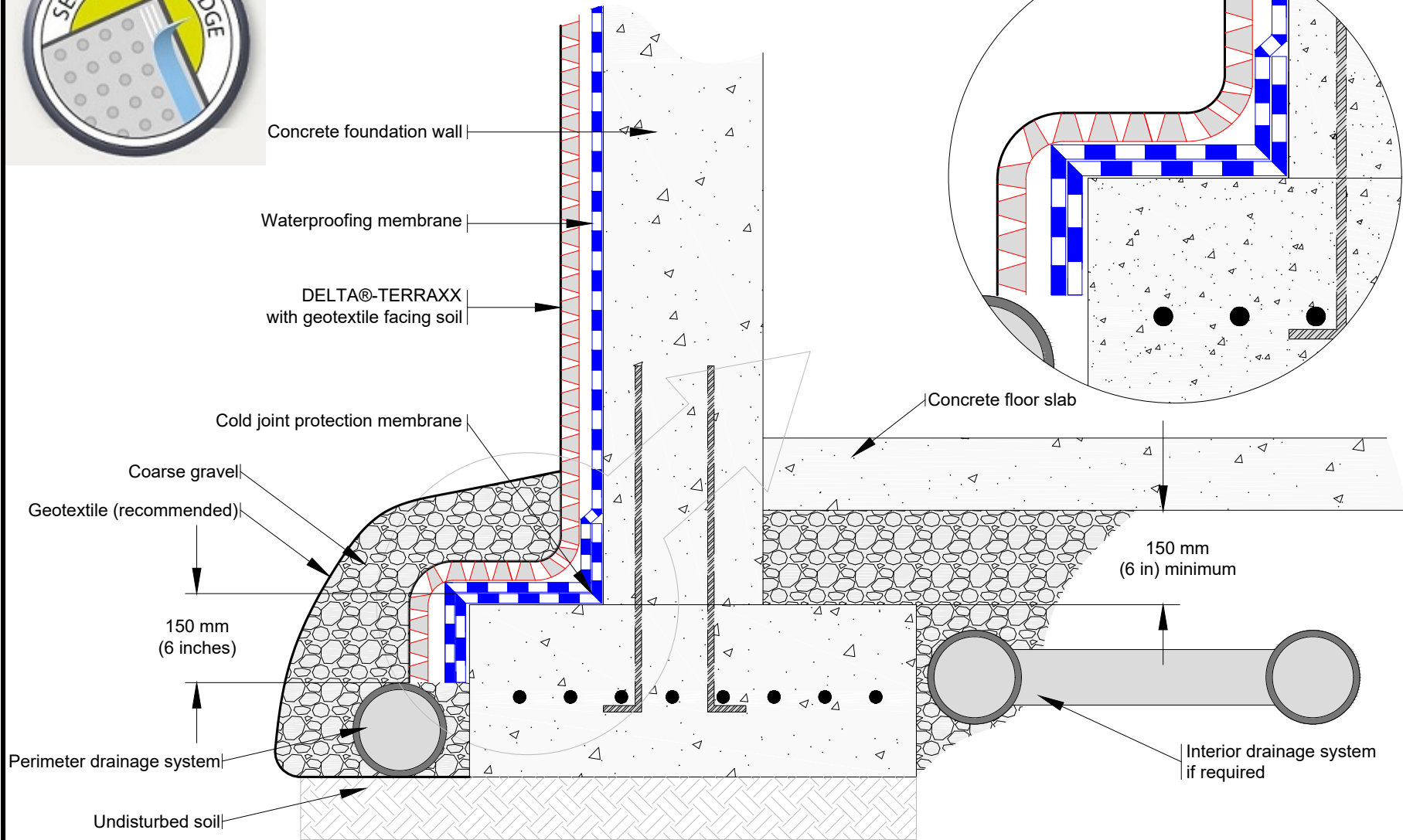

SUBSTANTIAL EFFORT HAS BEEN MADE TO ENSURE THAT THE INFORMATION IN THIS DETAIL DRAWING IS ACCURATE. DÖRKEN SYSTEMS INC. CANNOT ACCEPT RESPONSIBILITY FOR ANY ERRORS OR OVERSIGHTS IN THE USE OF THIS MATERIAL OR IN THE PREPARATION OF ARCHITECTURAL OR ENGINEERING PLANS. THE DESIGN PROFESSIONAL MUST RECOGNIZE THAT NO DESIGN DETAIL CAN SUBSTITUTE FOR EXPERIENCED ENGINEERING AND PROFESSIONAL JUDGEMENT.

TITLE:

## DELTA®-TERRAXX WITH FOUNDATION WALL AND ELEVATED FLOOR SLAB

DRAWN BY: Krzysztof Apriasz C. Tech., CPHC®

DATE: November 15, 2022  
SCALE: NTS

FILE NAME:  
DTERRAXX\_2



# DELTA®



Note: gravel not shown for clarity

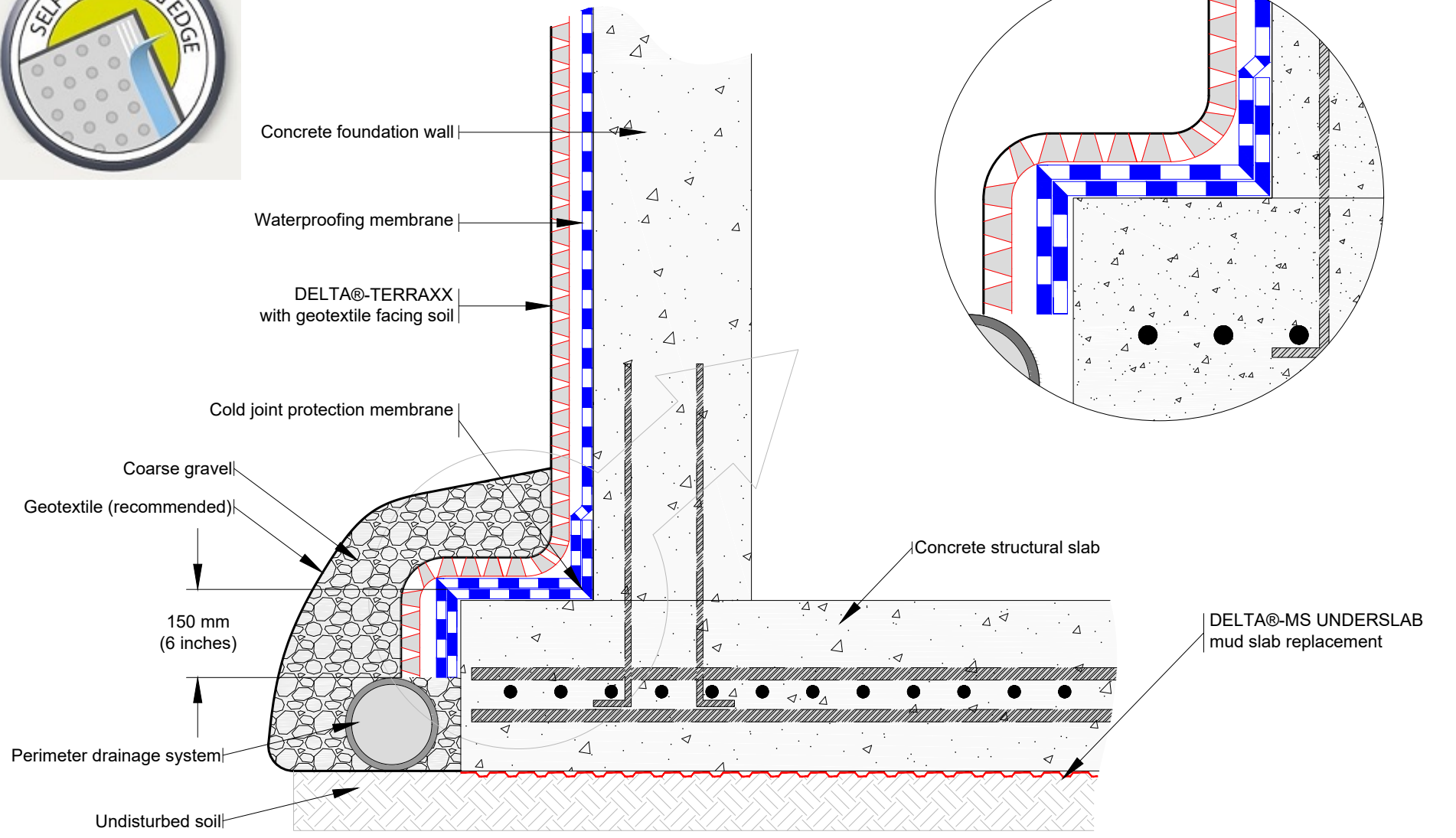

SUBSTANTIAL EFFORT HAS BEEN MADE TO ENSURE THAT THE INFORMATION IN THIS DETAIL DRAWING IS ACCURATE. DÖRKEN SYSTEMS INC. CANNOT ACCEPT RESPONSIBILITY FOR ANY ERRORS OR OVERSIGHTS IN THE USE OF THIS MATERIAL OR IN THE PREPARATION OF ARCHITECTURAL OR ENGINEERING PLANS. THE DESIGN PROFESSIONAL MUST RECOGNIZE THAT NO DESIGN DETAIL CAN SUBSTITUTE FOR EXPERIENCED ENGINEERING AND PROFESSIONAL JUDGEMENT.

TITLE:

DELTA®-TERRAXX WITH FOUNDATION WALL ON STRUCTURAL SLAB

DRAWN BY: Krzysztof Apriasz C. Tech., CPHC®

DATE: November 15, 2022  
SCALE: NTS

FILE NAME:  
DTERRAXX\_3



DELTA®

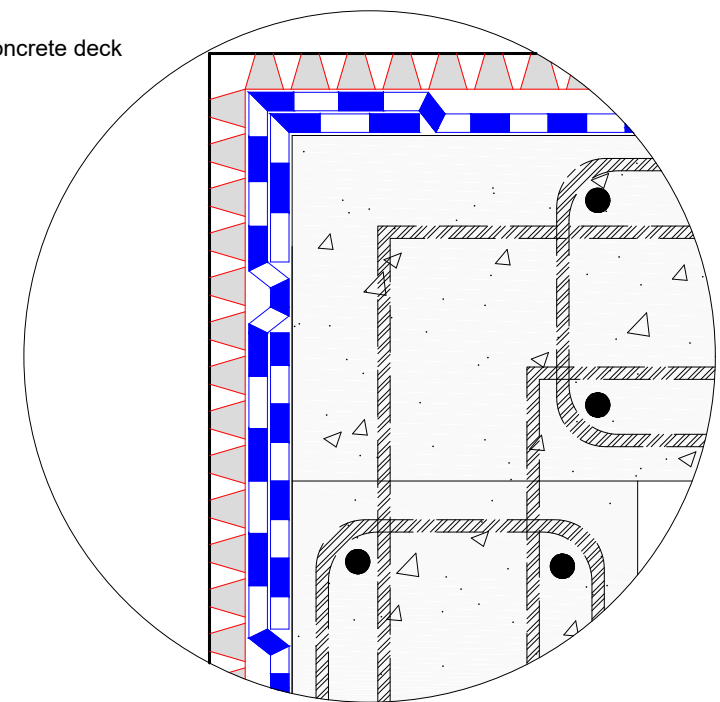
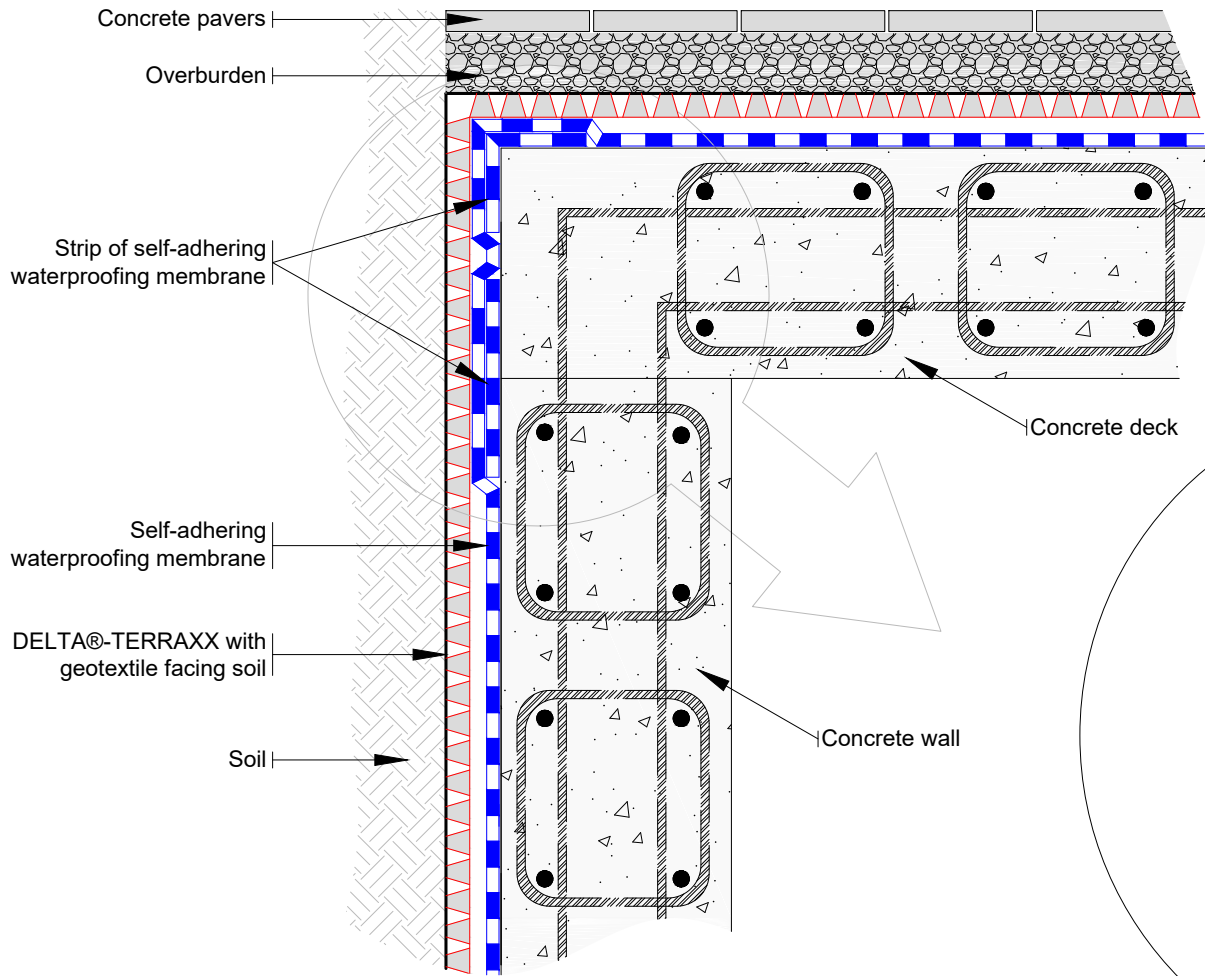

Note: soil and pavers not shown for clarity

SUBSTANTIAL EFFORT HAS BEEN MADE TO ENSURE THAT THE INFORMATION IN THIS DETAIL DRAWING IS ACCURATE. DÖRKEN SYSTEMS INC. CANNOT ACCEPT RESPONSIBILITY FOR ANY ERRORS OR OVERSIGHTS IN THE USE OF THIS MATERIAL OR IN THE PREPARATION OF ARCHITECTURAL OR ENGINEERING PLANS. THE DESIGN PROFESSIONAL MUST RECOGNIZE THAT NO DESIGN DETAIL CAN SUBSTITUTE FOR EXPERIENCED ENGINEERING AND PROFESSIONAL JUDGEMENT.

TITLE:  
**DELTA®-TERRAXX WITH PLAZA DECK TO WALL TIE-IN DETAIL**



DRAWN BY: Krzysztof Apriasz C. Tech., CPHC®

DATE: November 15, 2022  
 SCALE: NTS

FILE NAME:  
 DTERRAXX\_4

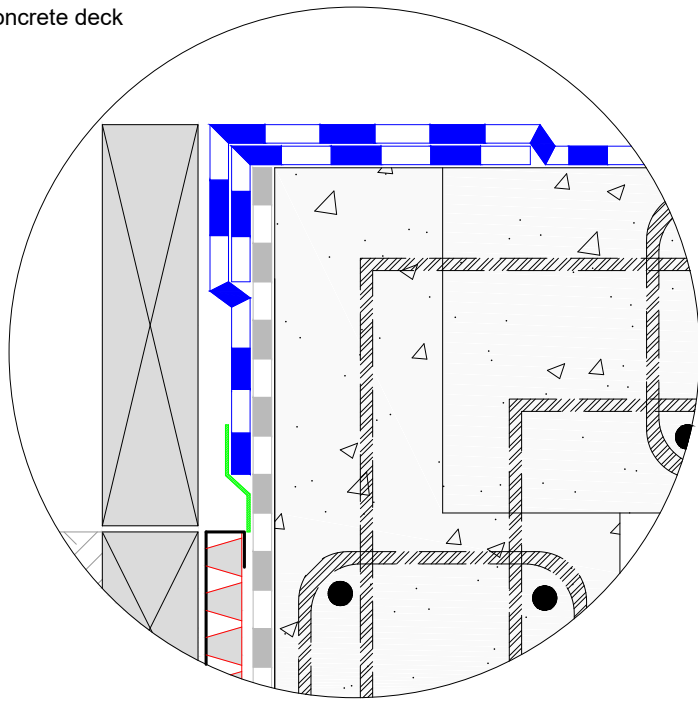
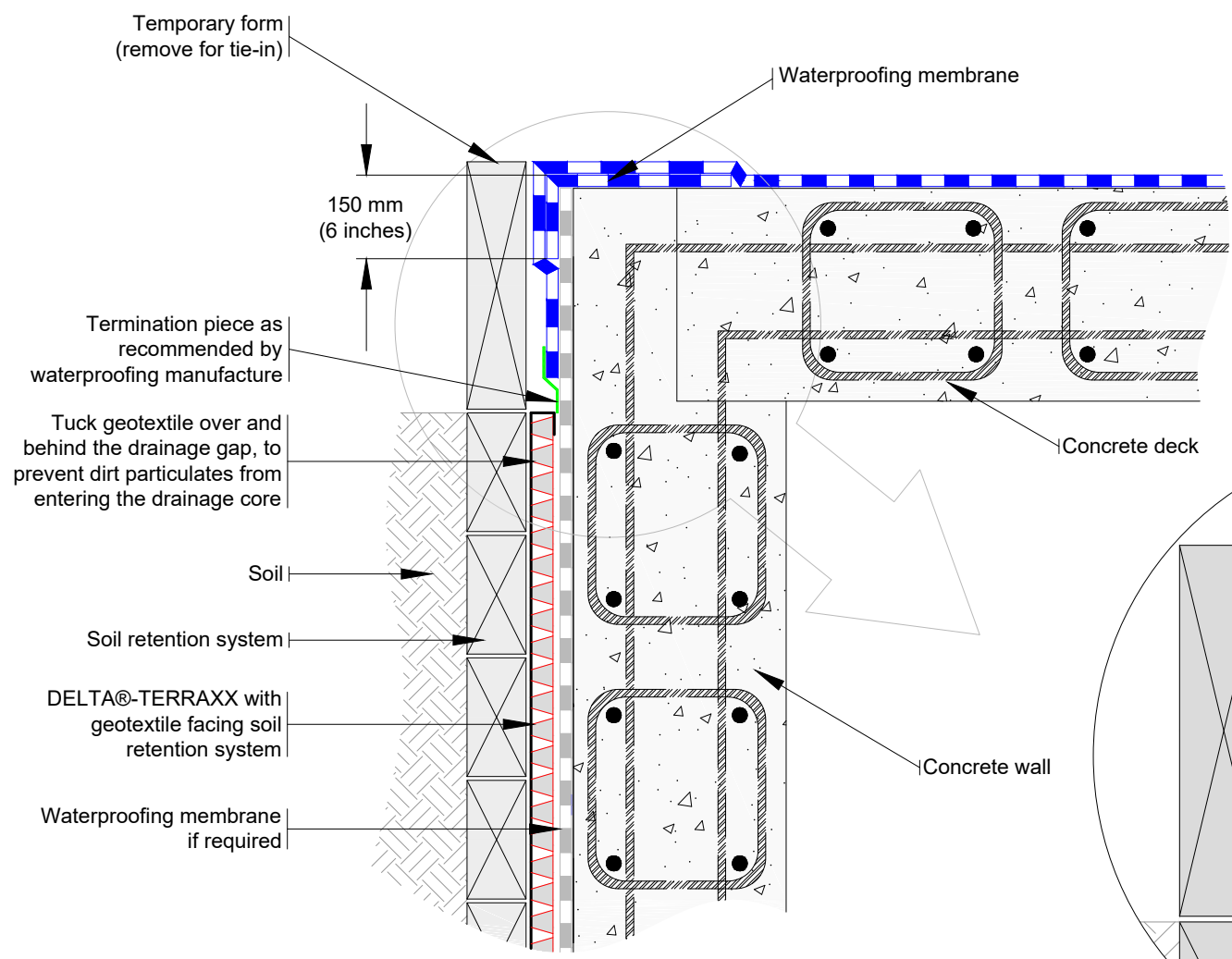

SUBSTANTIAL EFFORT HAS BEEN MADE TO ENSURE THAT THE INFORMATION IN THIS DETAIL DRAWING IS ACCURATE. DÖRKEN SYSTEMS INC. CANNOT ACCEPT RESPONSIBILITY FOR ANY ERRORS OR OVERSIGHTS IN THE USE OF THIS MATERIAL OR IN THE PREPARATION OF ARCHITECTURAL OR ENGINEERING PLANS. THE DESIGN PROFESSIONAL MUST RECOGNIZE THAT NO DESIGN DETAIL CAN SUBSTITUTE FOR EXPERIENCED ENGINEERING AND PROFESSIONAL JUDGEMENT.

TITLE:  
**DELTA®-TERRAXX with PLAZA DECK  
 WATERPROOFING TIE-IN TO  
 VERTICAL BLIND SIDE WATERPROOFING DETAIL**



DRAWN BY:  
 Krzysztof Apiaasz C. Tech., CPHC®

DATE: February 17, 2017  
 SCALE: NTS

FILE NAME:  
 DTERRAXX\_5

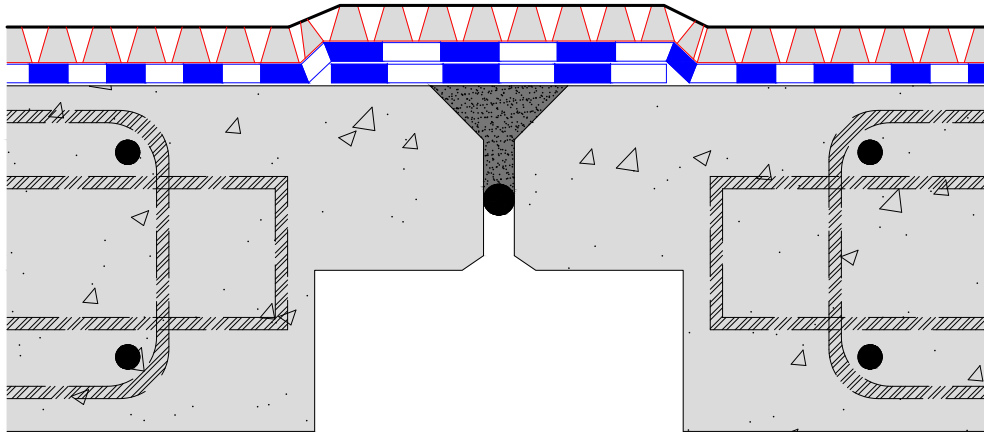

Note: For joint where movement is expected (active joints) see expansion joint cover detail



Note: Typical DELTA®-TERRAXX overlap

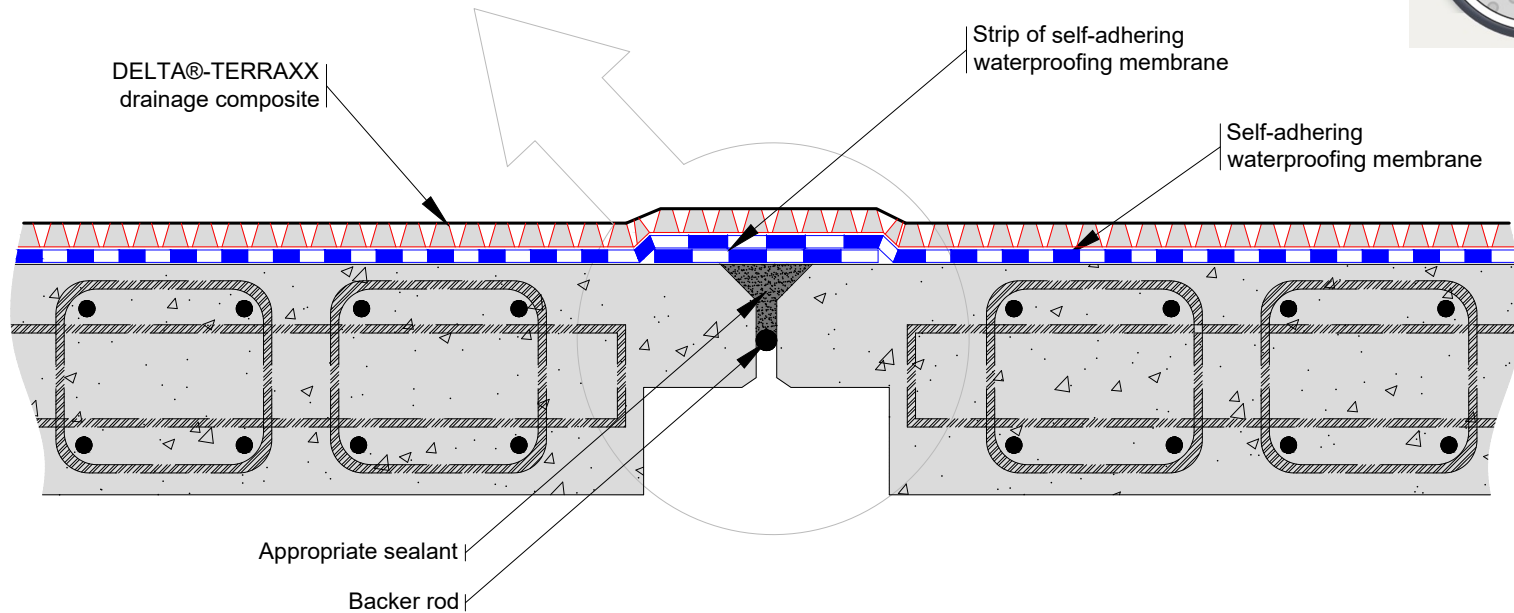

SUBSTANTIAL EFFORT HAS BEEN MADE TO ENSURE THAT THE INFORMATION IN THIS DETAIL DRAWING IS ACCURATE. DÖRKEN SYSTEMS INC. CANNOT ACCEPT RESPONSIBILITY FOR ANY ERRORS OR OVERSIGHTS IN THE USE OF THIS MATERIAL OR IN THE PREPARATION OF ARCHITECTURAL OR ENGINEERING PLANS. THE DESIGN PROFESSIONAL MUST RECOGNIZE THAT NO DESIGN DETAIL CAN SUBSTITUTE FOR EXPERIENCED ENGINEERING AND PROFESSIONAL JUDGEMENT.

TITLE:

## DELTA®-TERRAXX WITH PASSIVE JOINT COVER DETAIL

DRAWN BY: Krzysztof Apriasz C. Tech., CPHC®

DATE: November 15, 2022  
SCALE: NTS

FILE NAME:  
DTERRAXX\_6

 **DÖRKEN**

**DELTA®**

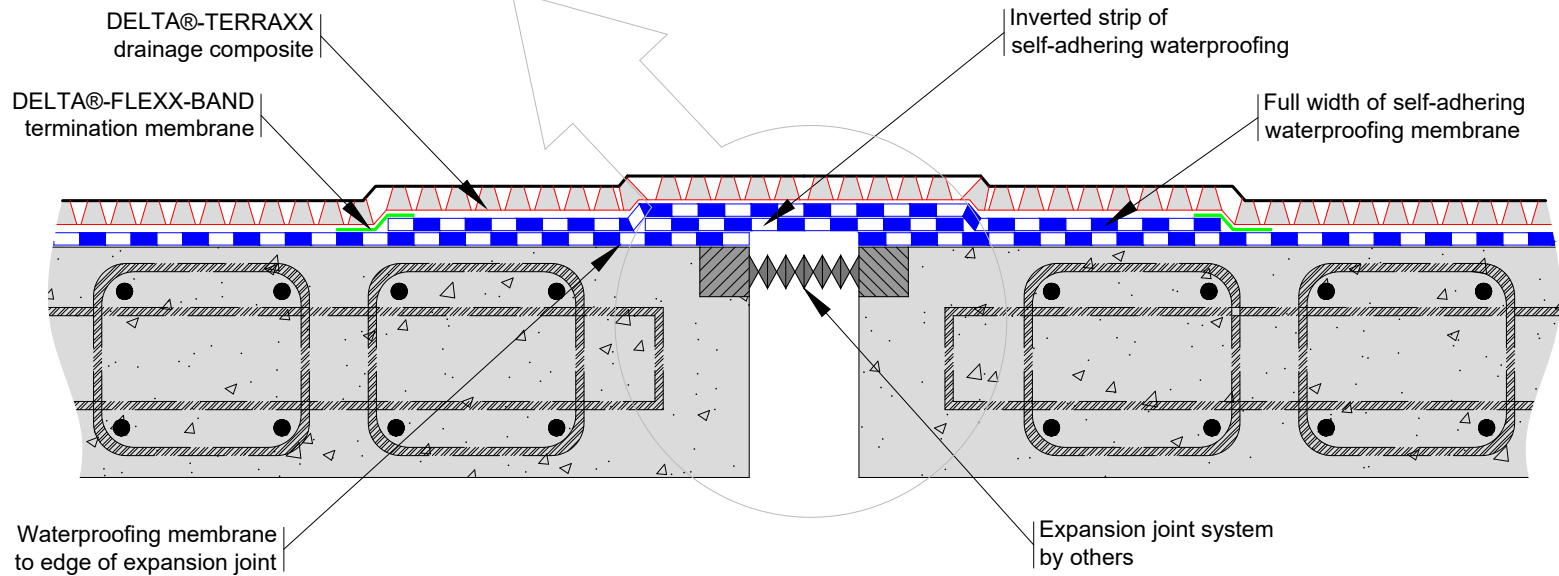
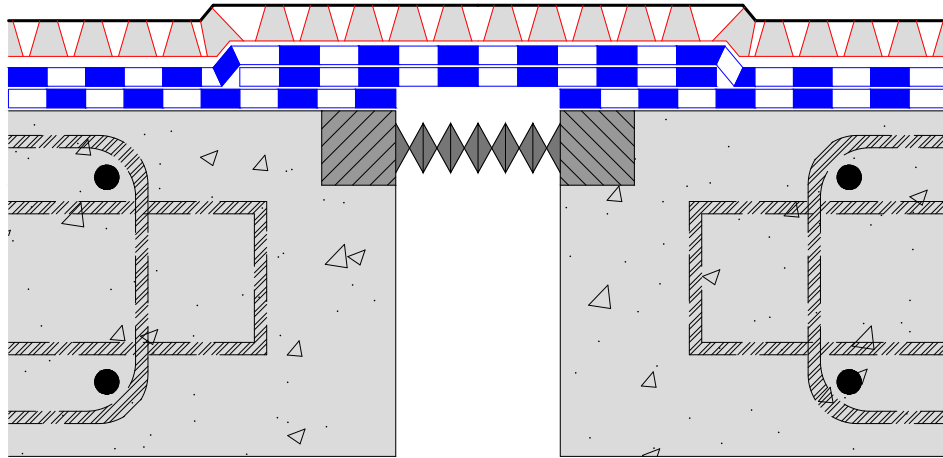

SUBSTANTIAL EFFORT HAS BEEN MADE TO ENSURE THAT THE INFORMATION IN THIS DETAIL DRAWING IS ACCURATE. DÖRKEN SYSTEMS INC. CANNOT ACCEPT RESPONSIBILITY FOR ANY ERRORS OR OVERSIGHTS IN THE USE OF THIS MATERIAL OR IN THE PREPARATION OF ARCHITECTURAL OR ENGINEERING PLANS. THE DESIGN PROFESSIONAL MUST RECOGNIZE THAT NO DESIGN DETAIL CAN SUBSTITUTE FOR EXPERIENCED ENGINEERING AND PROFESSIONAL JUDGEMENT.

TITLE:

**DELTA®-TERRAXX WITH EXPANSION  
 JOINT COVER DECK DETAIL WITH  
 MOVEMENT LESS THAN 13 mm (½ INCHES)**

DRAWN BY: Krzysztof Apriasz C. Tech., CPHC®

DATE: November 15, 2022  
 SCALE: NTS

FILE NAME:  
 DTERRAXX\_7



**DELTA®**

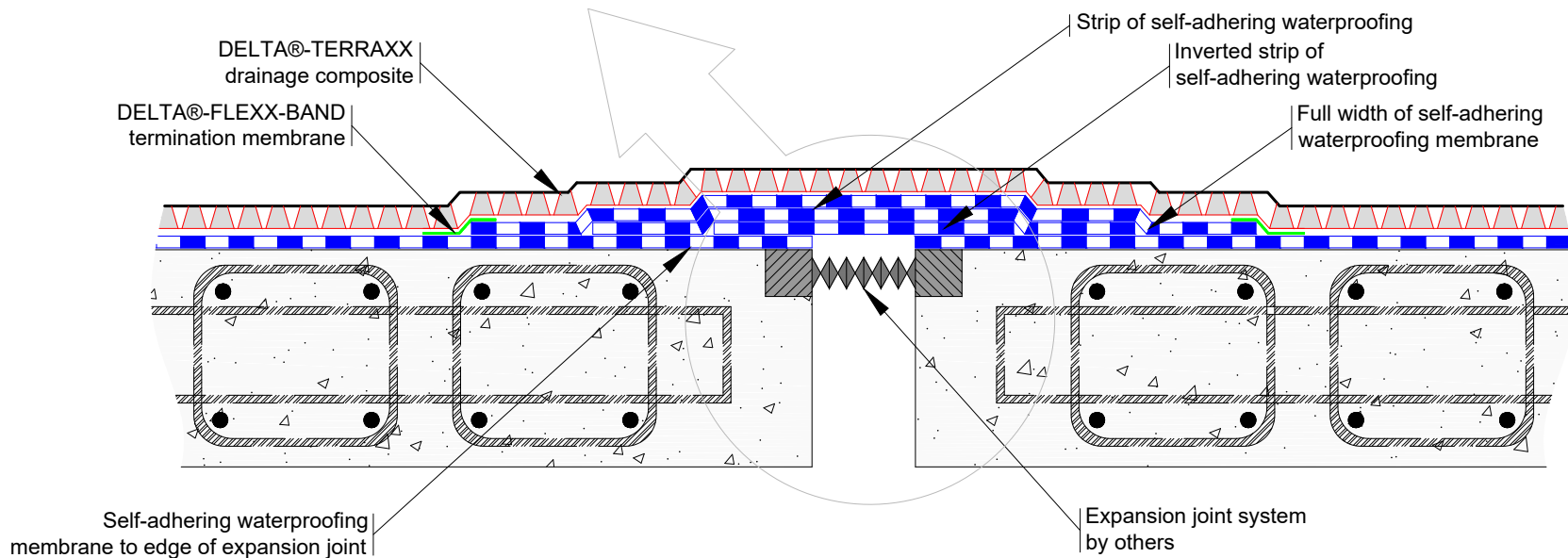
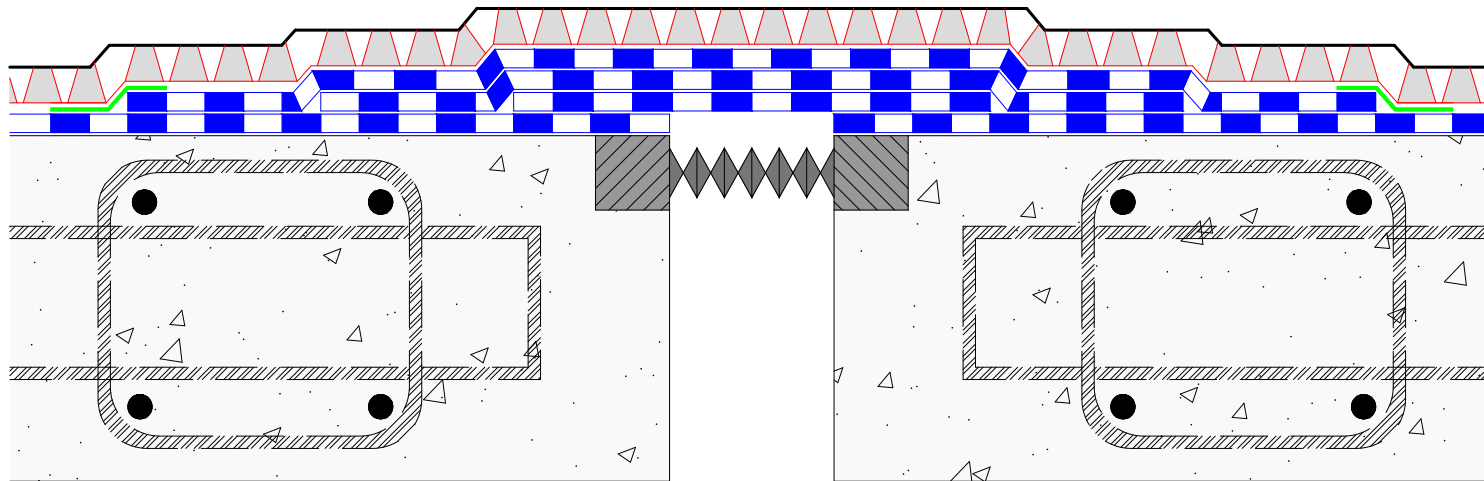

SUBSTANTIAL EFFORT HAS BEEN MADE TO ENSURE THAT THE INFORMATION IN THIS DETAIL DRAWING IS ACCURATE. DÖRKEN SYSTEMS INC. CANNOT ACCEPT RESPONSIBILITY FOR ANY ERRORS OR OVERSIGHTS IN THE USE OF THIS MATERIAL OR IN THE PREPARATION OF ARCHITECTURAL OR ENGINEERING PLANS. THE DESIGN PROFESSIONAL MUST RECOGNIZE THAT NO DESIGN DETAIL CAN SUBSTITUTE FOR EXPERIENCED ENGINEERING AND PROFESSIONAL JUDGEMENT.

TITLE:

**DELTA®-TERRAXX WITH EXPANSION JOINT  
COVER DECK DETAIL WITH MOVEMENT**

**MORE THAN 13 mm (1/2 INCHES)**

DRAWN BY: Krzysztof Apriasz C. Tech., CPHC®

DATE: November 15, 2022  
SCALE: NTS

FILE NAME:  
DTERRAXX\_8



**DELTA®**



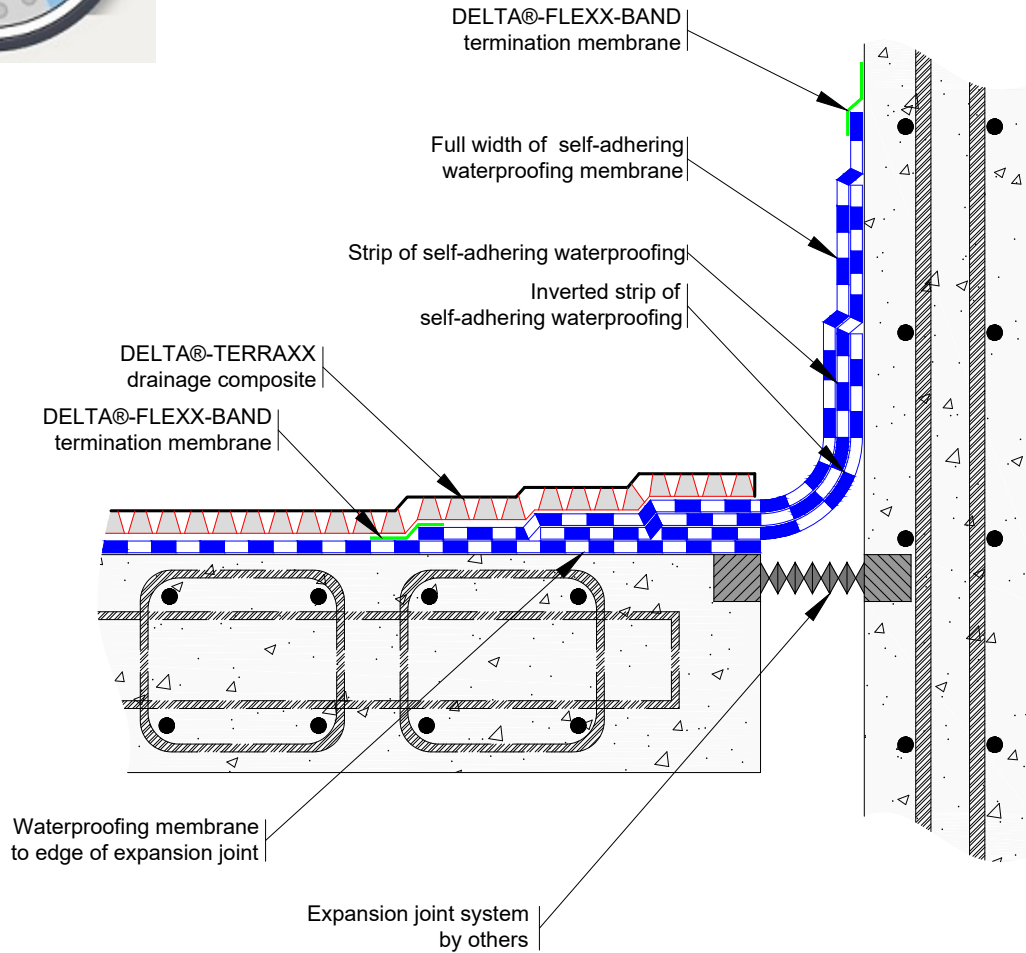

SUBSTANTIAL EFFORT HAS BEEN MADE TO ENSURE THAT THE INFORMATION IN THIS DETAIL DRAWING IS ACCURATE. DÖRKEN SYSTEMS INC. CANNOT ACCEPT RESPONSIBILITY FOR ANY ERRORS OR OVERSIGHTS IN THE USE OF THIS MATERIAL OR IN THE PREPARATION OF ARCHITECTURAL OR ENGINEERING PLANS. THE DESIGN PROFESSIONAL MUST RECOGNIZE THAT NO DESIGN DETAIL CAN SUBSTITUTE FOR EXPERIENCED ENGINEERING AND PROFESSIONAL JUDGEMENT.

TITLE:

DELTA®-TERRAXX  
EXPANSION JOINT COVER  
DECK TO WALL JUNCTION DETAIL

DRAWN BY: Krzysztof Apiasz C. Tech., CPHC®

Date: November 16, 2022

File Name: DTERRAXX\_09



**DELTA®**

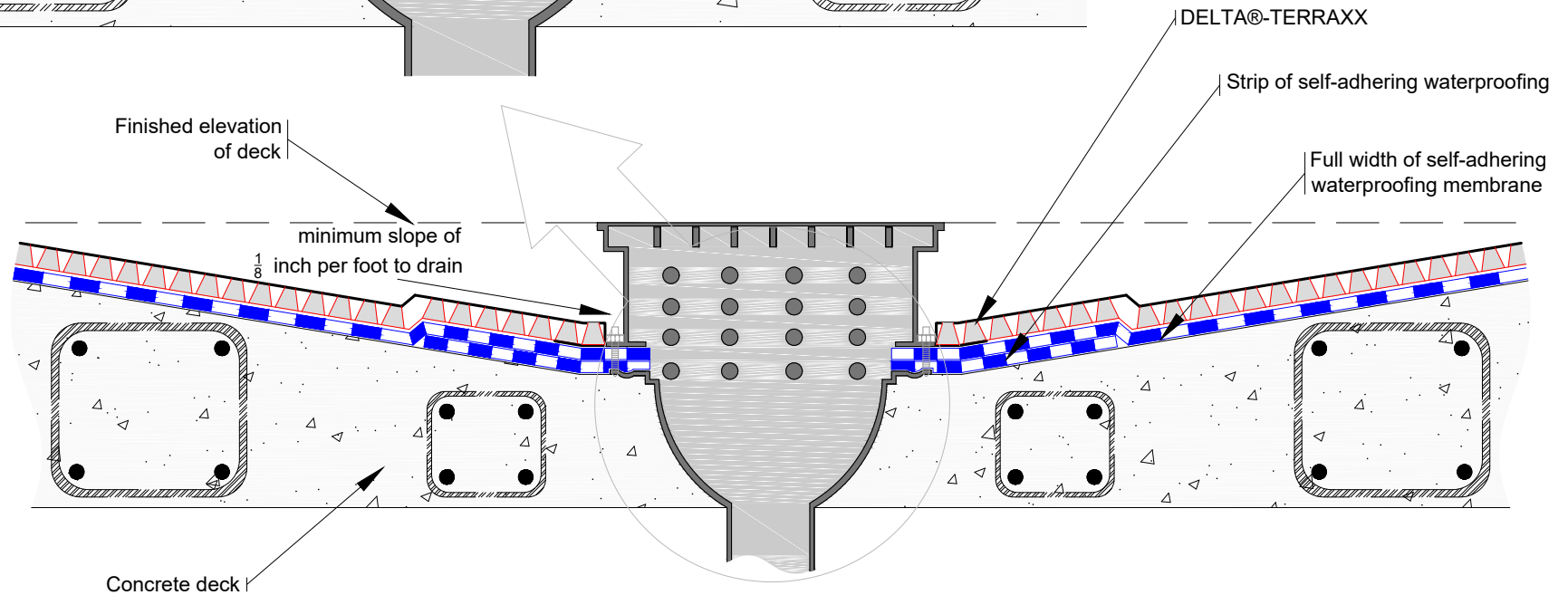
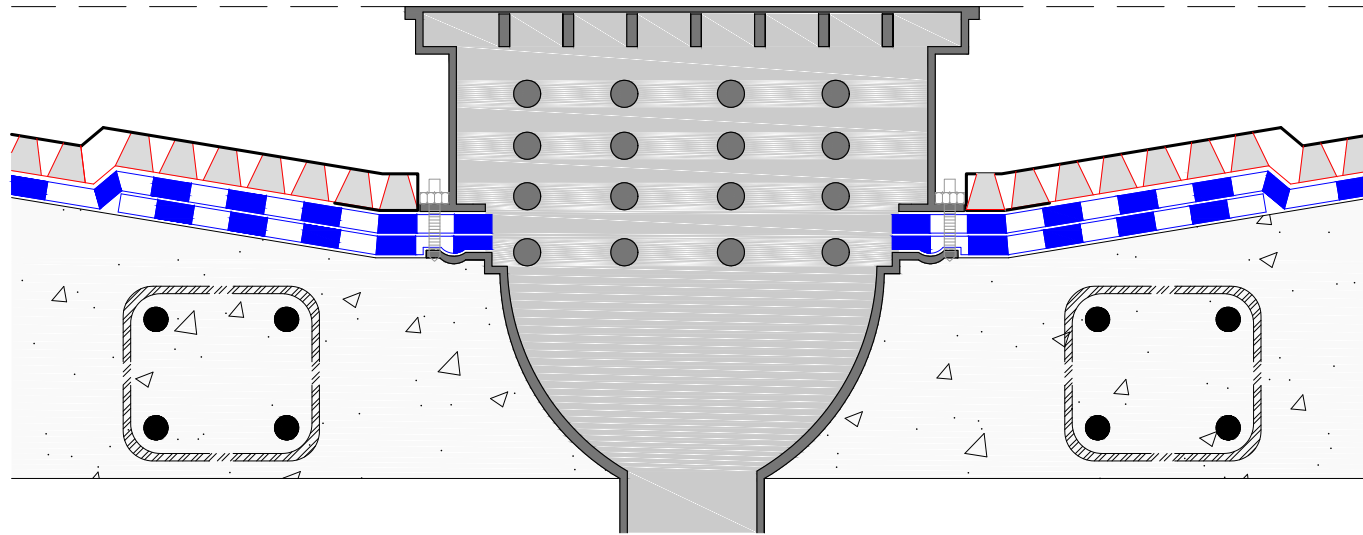

SUBSTANTIAL EFFORT HAS BEEN MADE TO ENSURE THAT THE INFORMATION IN THIS DETAIL DRAWING IS ACCURATE. DÖRKEN SYSTEMS INC. CANNOT ACCEPT RESPONSIBILITY FOR ANY ERRORS OR OVERSIGHTS IN THE USE OF THIS MATERIAL OR IN THE PREPARATION OF ARCHITECTURAL OR ENGINEERING PLANS. THE DESIGN PROFESSIONAL MUST RECOGNIZE THAT NO DESIGN DETAIL CAN SUBSTITUTE FOR EXPERIENCED ENGINEERING AND PROFESSIONAL JUDGEMENT.

TITLE:

**DELTA®-TERRAXX  
WITH TYPICAL DRAIN DETAIL**

DRAWN BY: Krzysztof Apriasz C. Tech., CPHC®

DATE: November 16, 2022  
SCALE: NTS

FILE NAME:  
DTERRAXX\_10



**DELTA®**

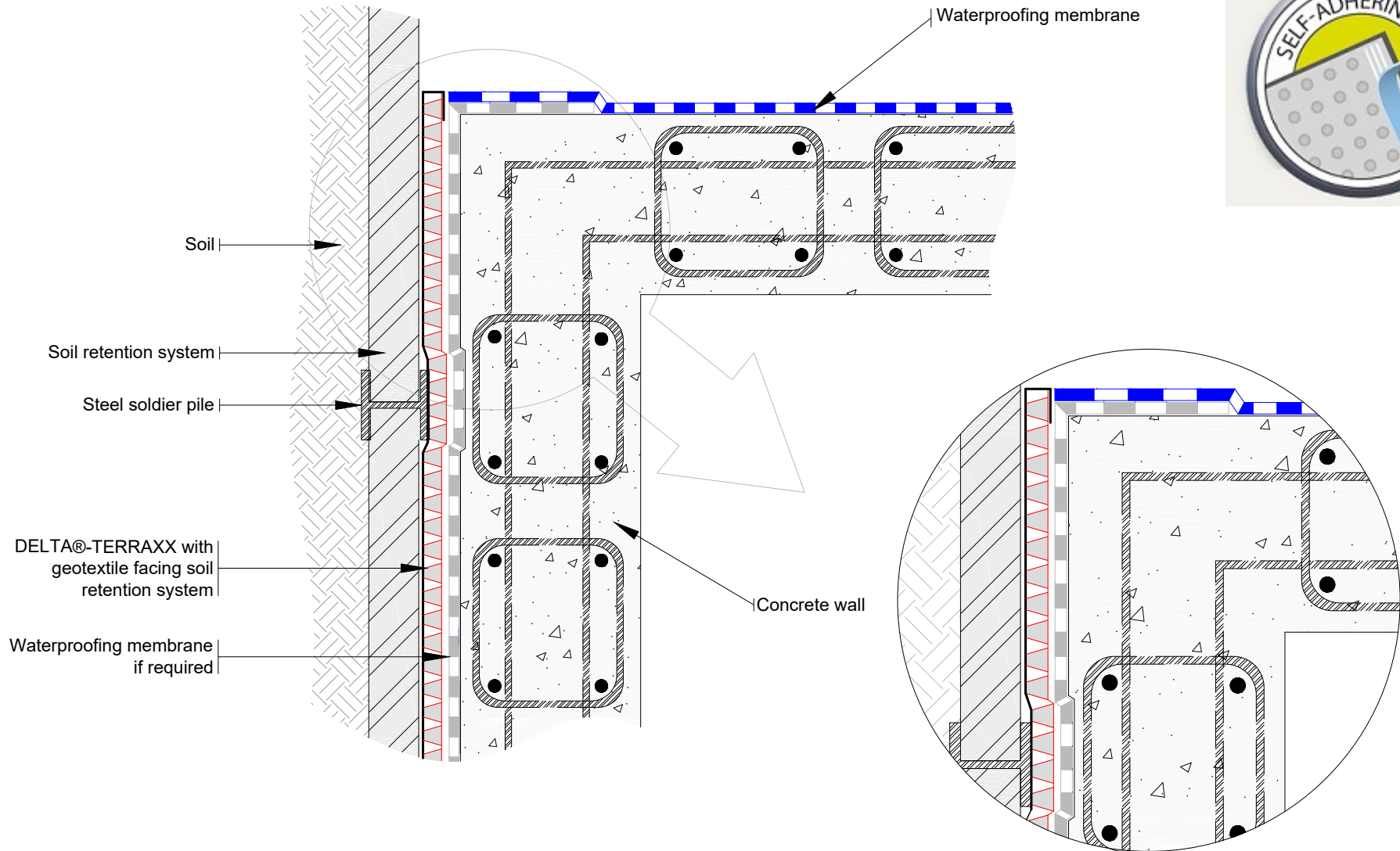

SUBSTANTIAL EFFORT HAS BEEN MADE TO ENSURE THAT THE INFORMATION IN THIS DETAIL DRAWING IS ACCURATE. DÖRKEN SYSTEMS INC. CANNOT ACCEPT RESPONSIBILITY FOR ANY ERRORS OR OVERSIGHTS IN THE USE OF THIS MATERIAL OR IN THE PREPARATION OF ARCHITECTURAL OR ENGINEERING PLANS. THE DESIGN PROFESSIONAL MUST RECOGNIZE THAT NO DESIGN DETAIL CAN SUBSTITUTE FOR EXPERIENCED ENGINEERING AND PROFESSIONAL JUDGEMENT.

TITLE:

**DELTA®-TERRAXX TIE-IN TO  
SELF-ADHERING WATERPROOFING  
MEMBRANE DETAIL**

DRAWN BY: Krzysztof Apriasz C. Tech., CPHC®

DATE: November 16, 2022  
SCALE: NTS

FILE NAME:  
DTARRAXX\_12



**DELTA®**

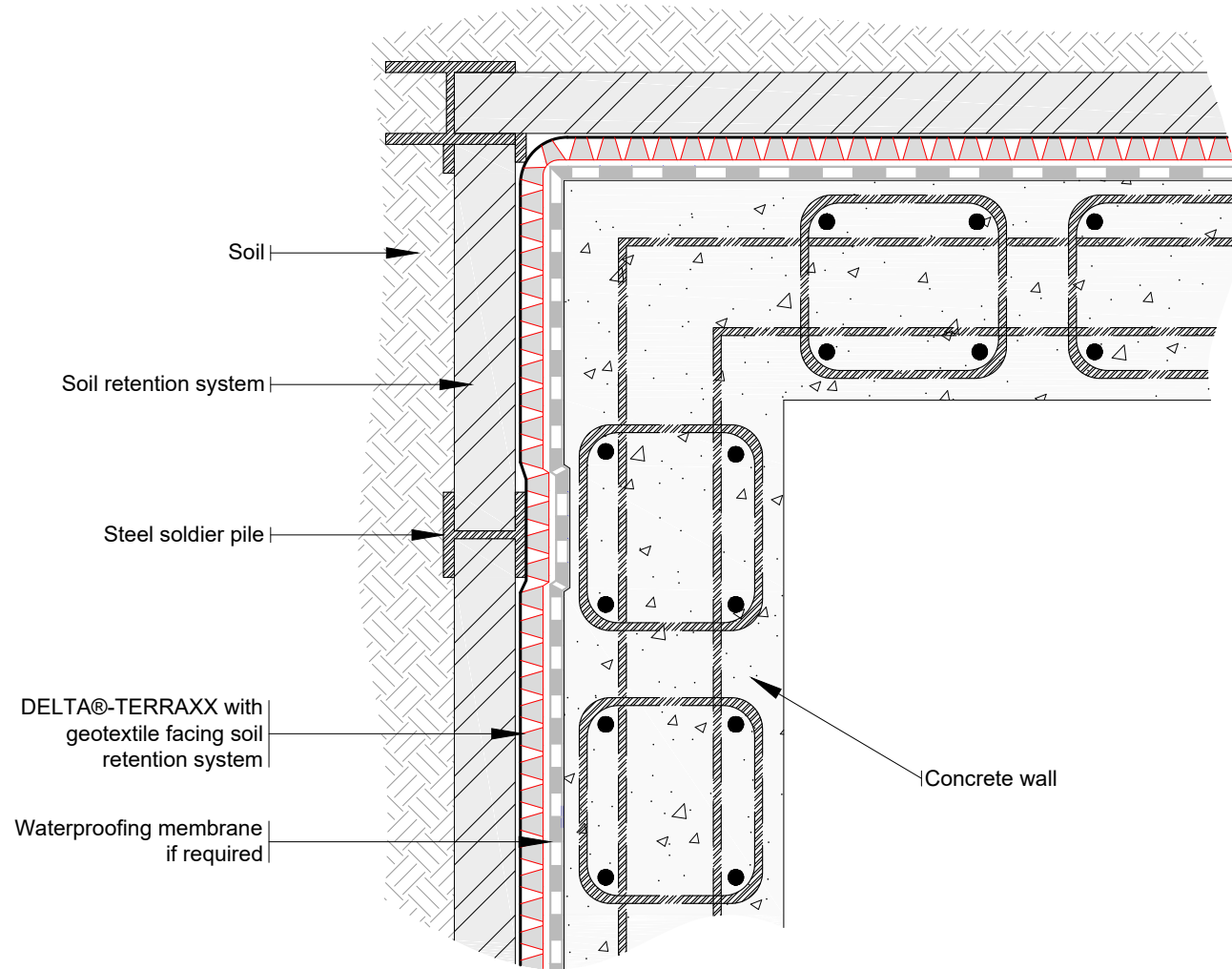

SUBSTANTIAL EFFORT HAS BEEN MADE TO ENSURE THAT THE INFORMATION IN THIS DETAIL DRAWING IS ACCURATE. DÖRKEN SYSTEMS INC. CANNOT ACCEPT RESPONSIBILITY FOR ANY ERRORS OR OVERSIGHTS IN THE USE OF THIS MATERIAL OR IN THE PREPARATION OF ARCHITECTURAL OR ENGINEERING PLANS. THE DESIGN PROFESSIONAL MUST RECOGNIZE THAT NO DESIGN DETAIL CAN SUBSTITUTE FOR EXPERIENCED ENGINEERING AND PROFESSIONAL JUDGEMENT.

TITLE:

### TYPICAL CORNER DETAIL DELTA®-TERRAXX

DRAWN BY: Krzysztof Apriasz C. Tech., CPHC®

DATE: November 16, 2022  
SCALE: NTS

FILE NAME:  
DTERRAXX\_13



# DELTA®

Note: overburden not shown for clarity

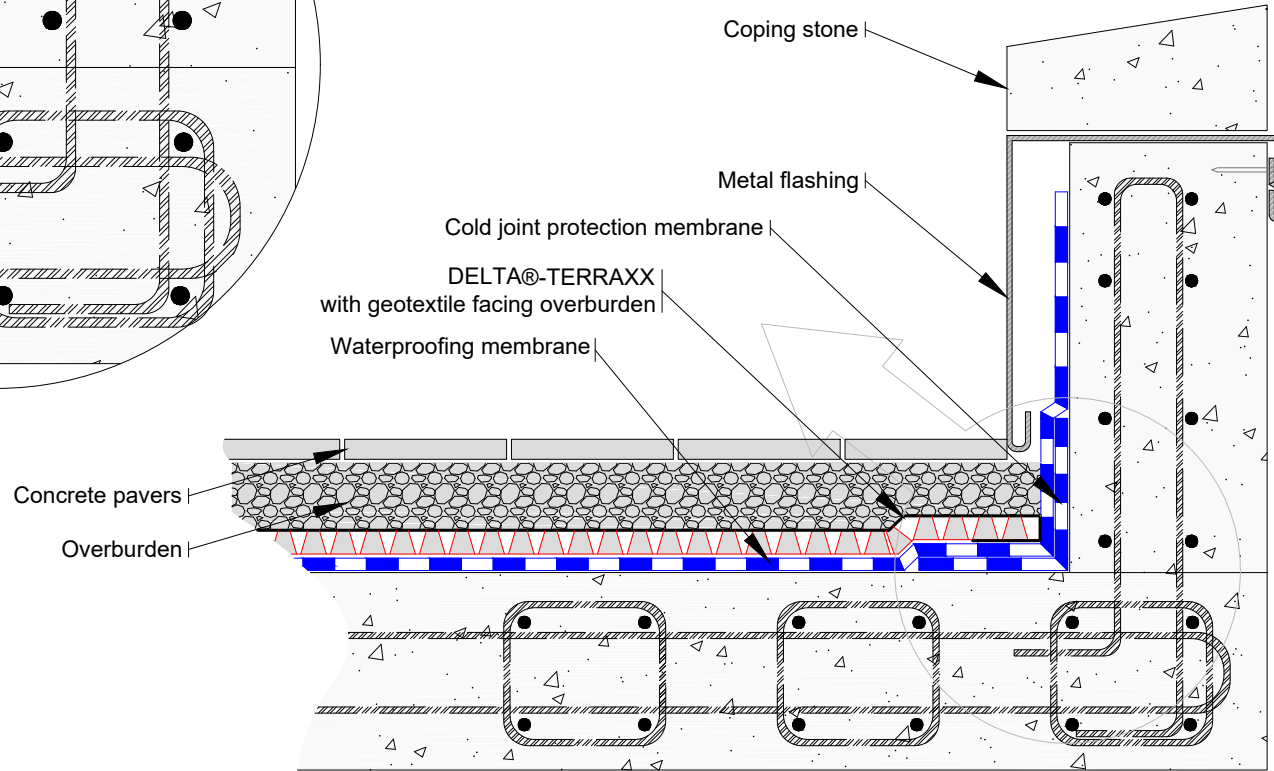
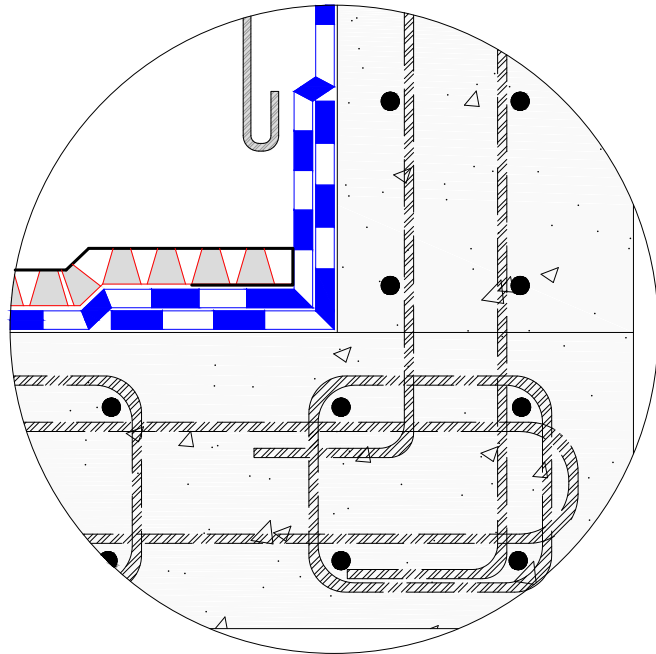

SUBSTANTIAL EFFORT HAS BEEN MADE TO ENSURE THAT THE INFORMATION IN THIS DETAIL DRAWING IS ACCURATE. DÖRKEN SYSTEMS INC. CANNOT ACCEPT RESPONSIBILITY FOR ANY ERRORS OR OVERSIGHTS IN THE USE OF THIS MATERIAL OR IN THE PREPARATION OF ARCHITECTURAL OR ENGINEERING PLANS. THE DESIGN PROFESSIONAL MUST RECOGNIZE THAT NO DESIGN DETAIL CAN SUBSTITUTE FOR EXPERIENCED ENGINEERING AND PROFESSIONAL JUDGEMENT.

TITLE:

### TYPICAL PARAPET DETAIL WITH DELTA®-TERRAXX

DRAWN BY: Krzysztof Apriasz C. Tech., CPHC®

DATE: November 16, 2022  
SCALE: NTS

FILE NAME:  
DTERRAXX\_14



# DELTA®

Note: overburden not shown for clarity

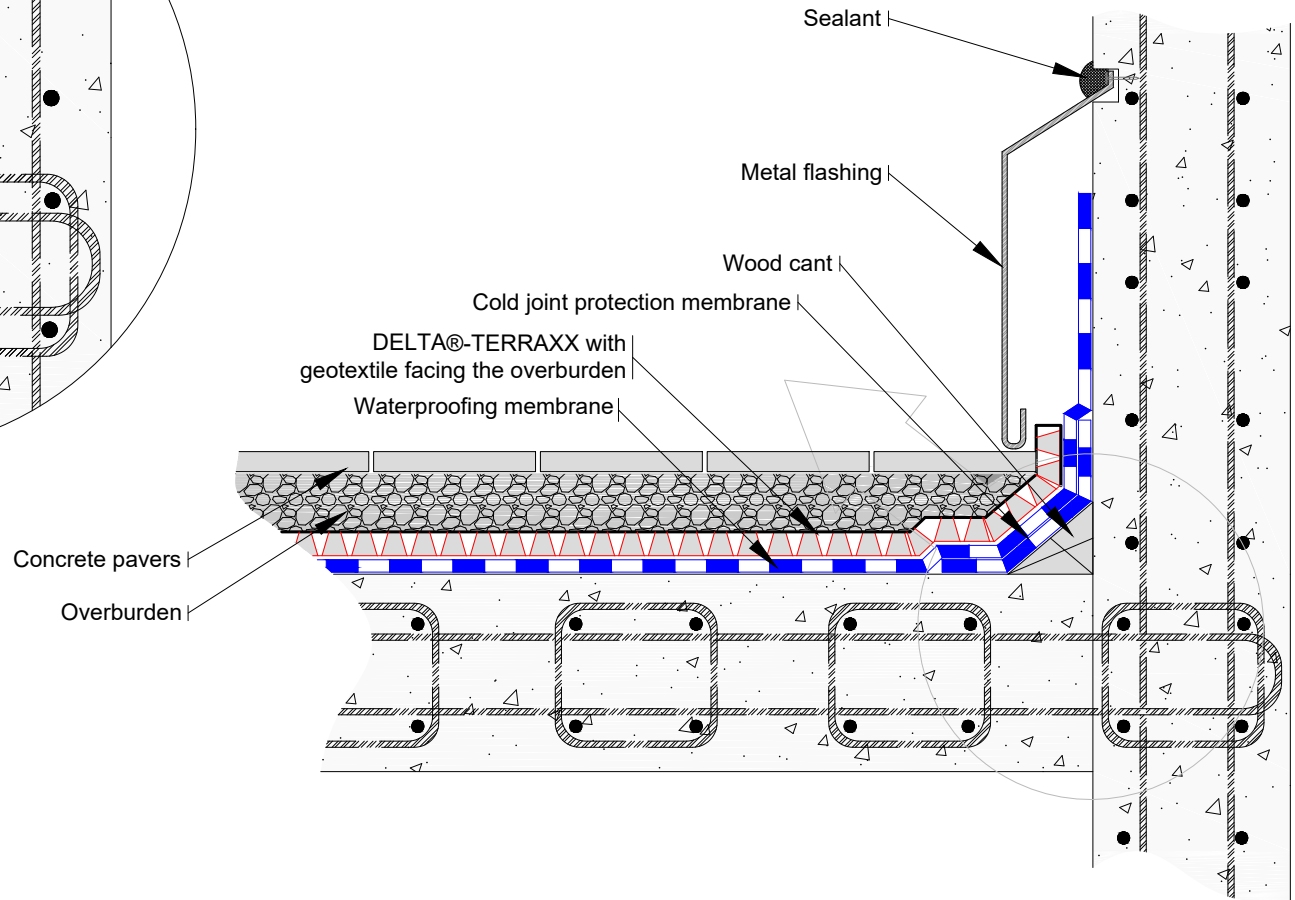
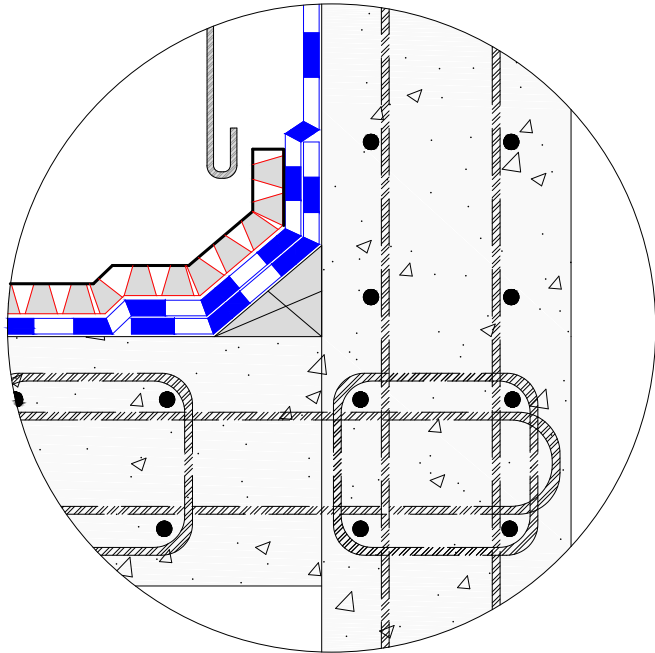

SUBSTANTIAL EFFORT HAS BEEN MADE TO ENSURE THAT THE INFORMATION IN THIS DETAIL DRAWING IS ACCURATE. DÖRKEN SYSTEMS INC. CANNOT ACCEPT RESPONSIBILITY FOR ANY ERRORS OR OVERSIGHTS IN THE USE OF THIS MATERIAL OR IN THE PREPARATION OF ARCHITECTURAL OR ENGINEERING PLANS. THE DESIGN PROFESSIONAL MUST RECOGNIZE THAT NO DESIGN DETAIL CAN SUBSTITUTE FOR EXPERIENCED ENGINEERING AND PROFESSIONAL JUDGEMENT.

TITLE:

### TYPICAL ROOF EDGE TERMINATION DETAIL WITH DELTA®-TERRAXX

DRAWN BY: Krzysztof Apriasz C. Tech., CPHC®

DATE: November 16, 2022  
SCALE: NTS

FILE NAME:  
DTERRAXX\_15



# DELTA®